

Kood	EG	Leht	
Joonis		Mootkava	1:50
Materjal		Kuup.	25.11.2014
Joonestlas		File	Wesselbaum.E.dwg

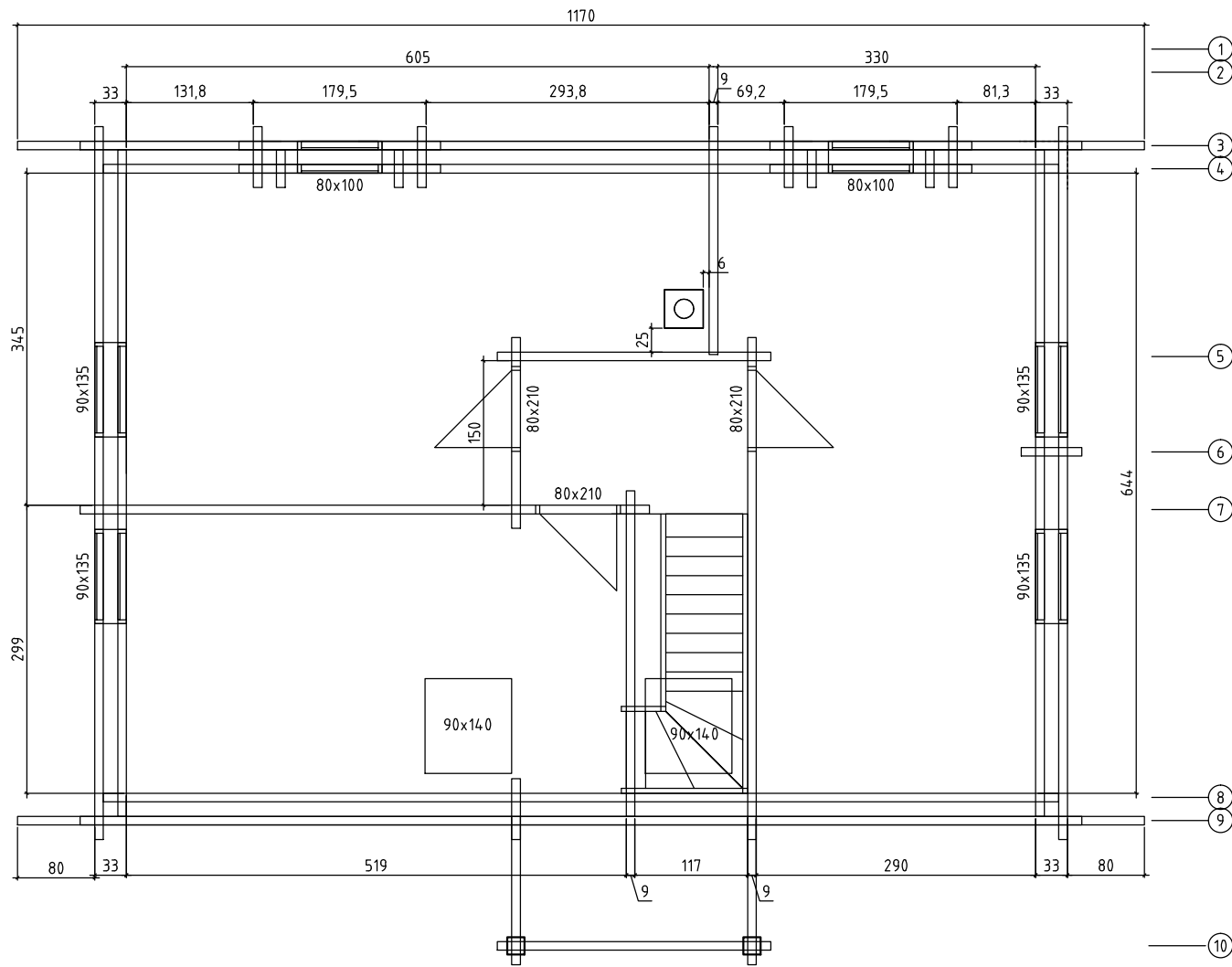

A B

C D

E F

G

H I

J K

L M

N O

P Q

Kood	DG	Leht	
Joonis		Mootkava	1:50
Materjal		Kuup.	25.11.2014
Joonestaj		File	Wesselbaum.E.dwg

DACHLATTUNG 30x50

KONTERLATTUNG 30x50

KANTHÖLZER 60x120(HOLZWEICHFASERDÄMMUNG)

SICHTSCHALUNG 18x120

SPARREN TOP DUO 80x180

LEIMBINDER 200x300

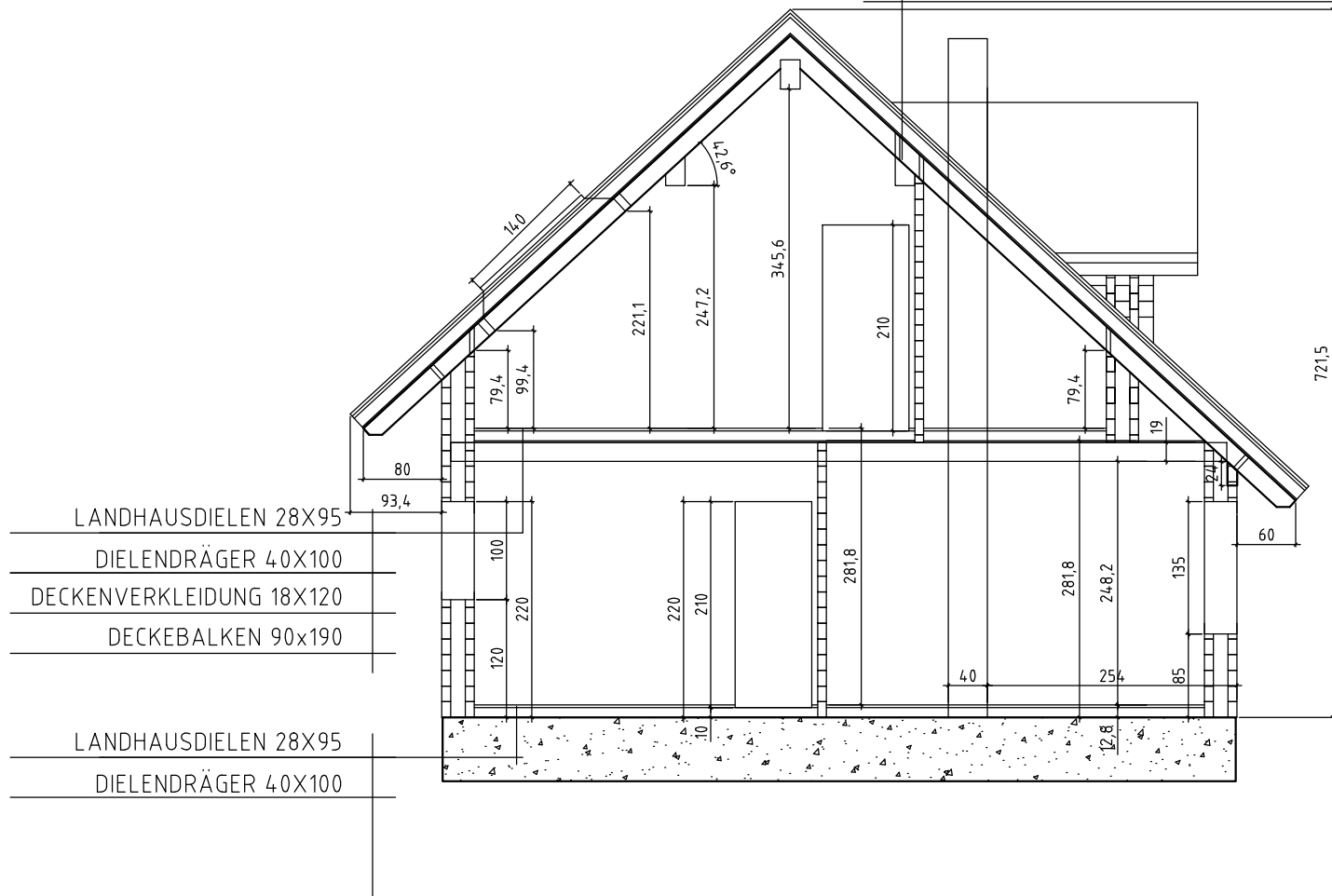

LANDHAUSDIELEN 28X95

DIELENDRÄGER 40X100

DECKENVERKLEIDUNG 18X120

DECKEBALKEN 90x190

LANDHAUSDIELEN 28X95

DIELENDRÄGER 40X100

Kood	SCHNITT	Leht
Joonis		Mootkava 1:50
Materjal		Kuup. 25.11.2014
Joonestaj		File Wesselbaum.E.dwg

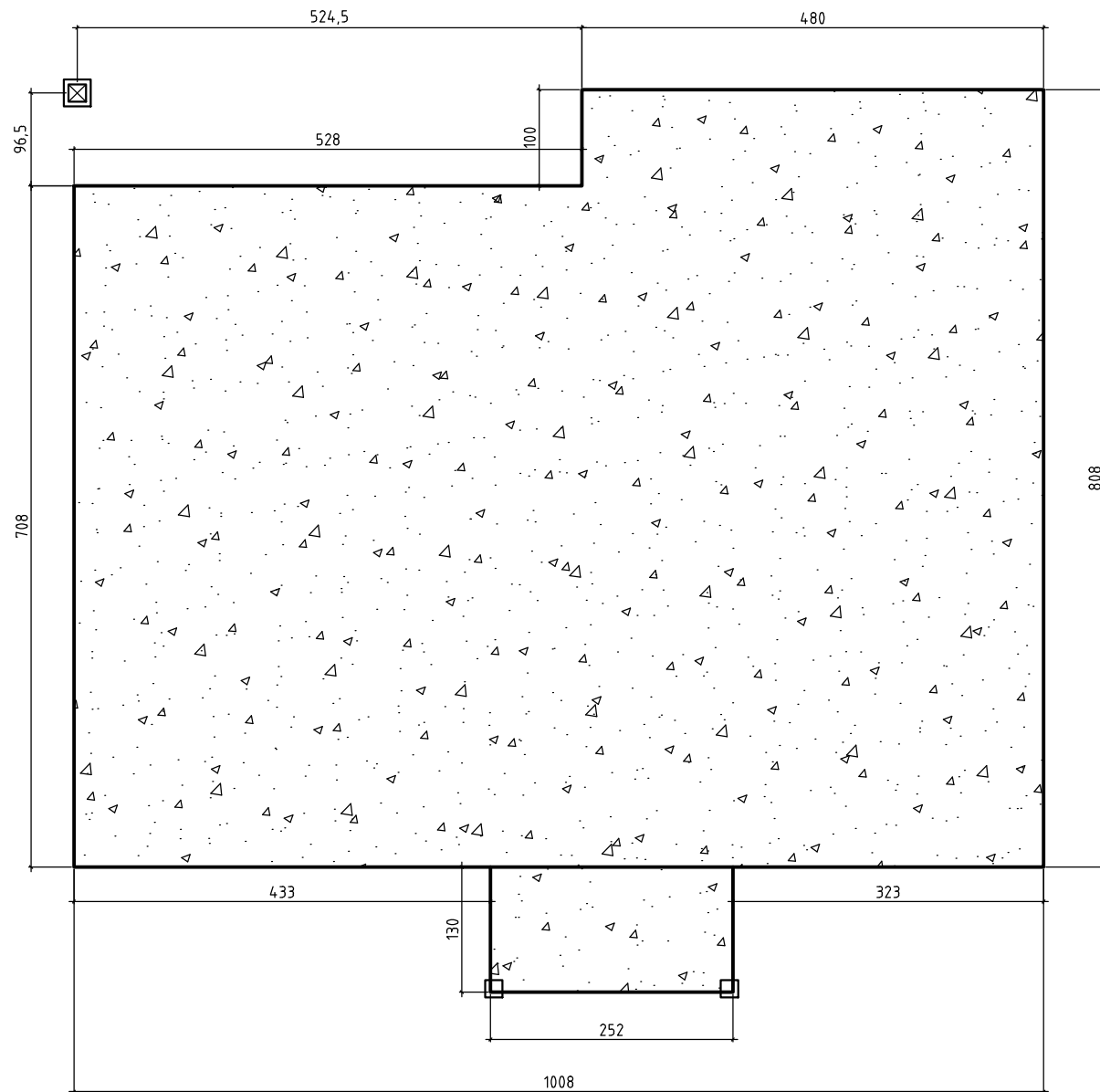
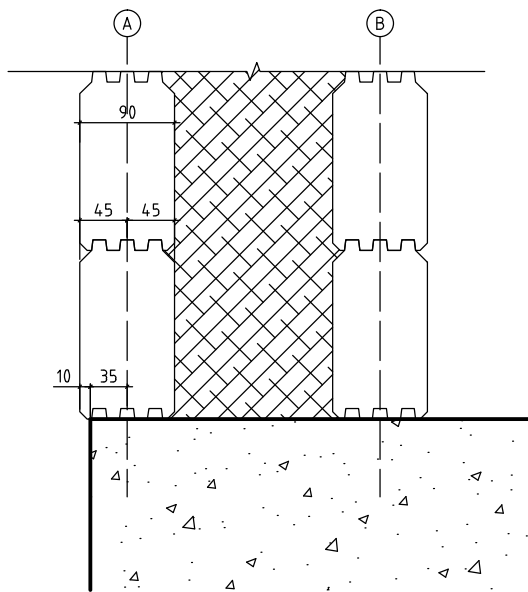

Kood	FUNDAMENTE	Leht	
Joonis		Moolkava	1:50
Materjal		Kuup.	25.11.2014
Joonestaja		File	Wesselbaum.E.dwg

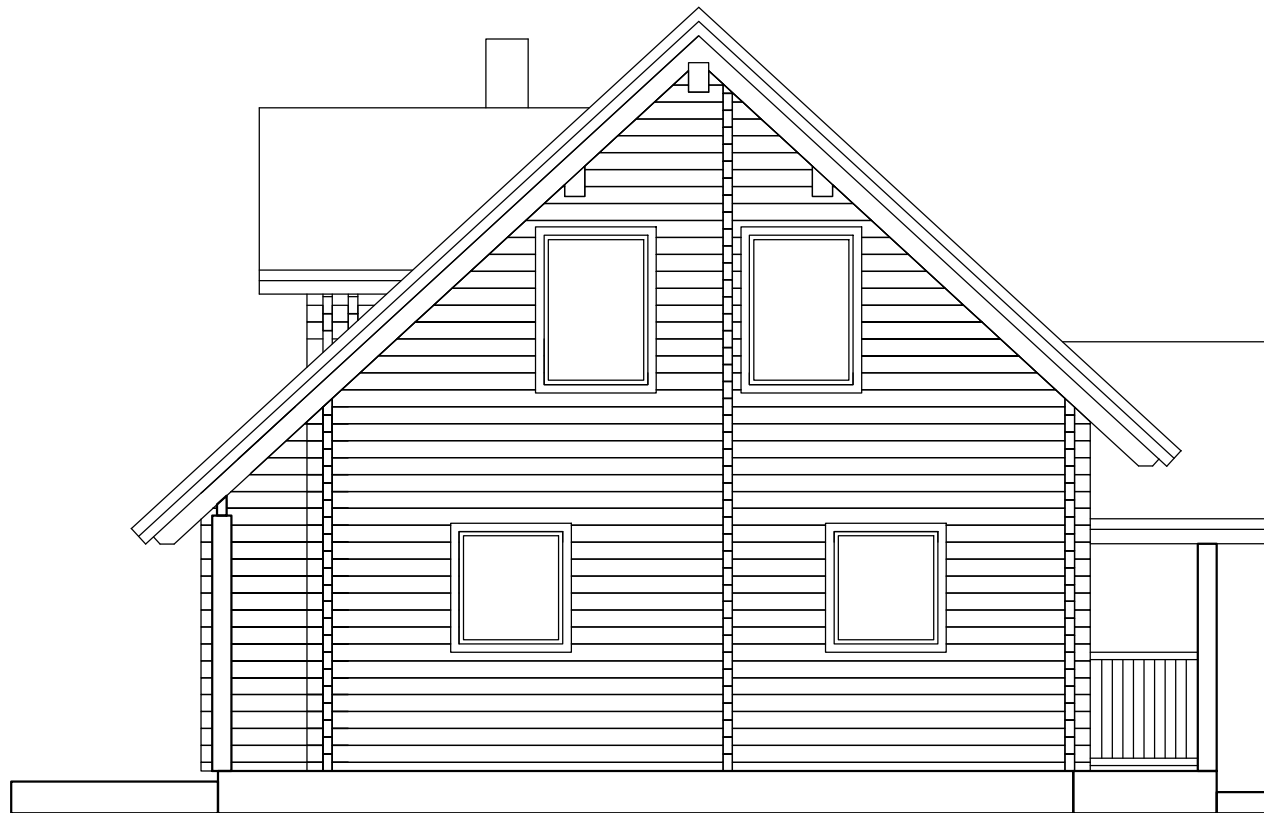

Kood	ANSICHT 2	Leht	
Joonis		Mootkava	1:50
Materjal	9x16	Kuup.	25.11.2014
Joonestas		File	Wesselbaum.E.dwg

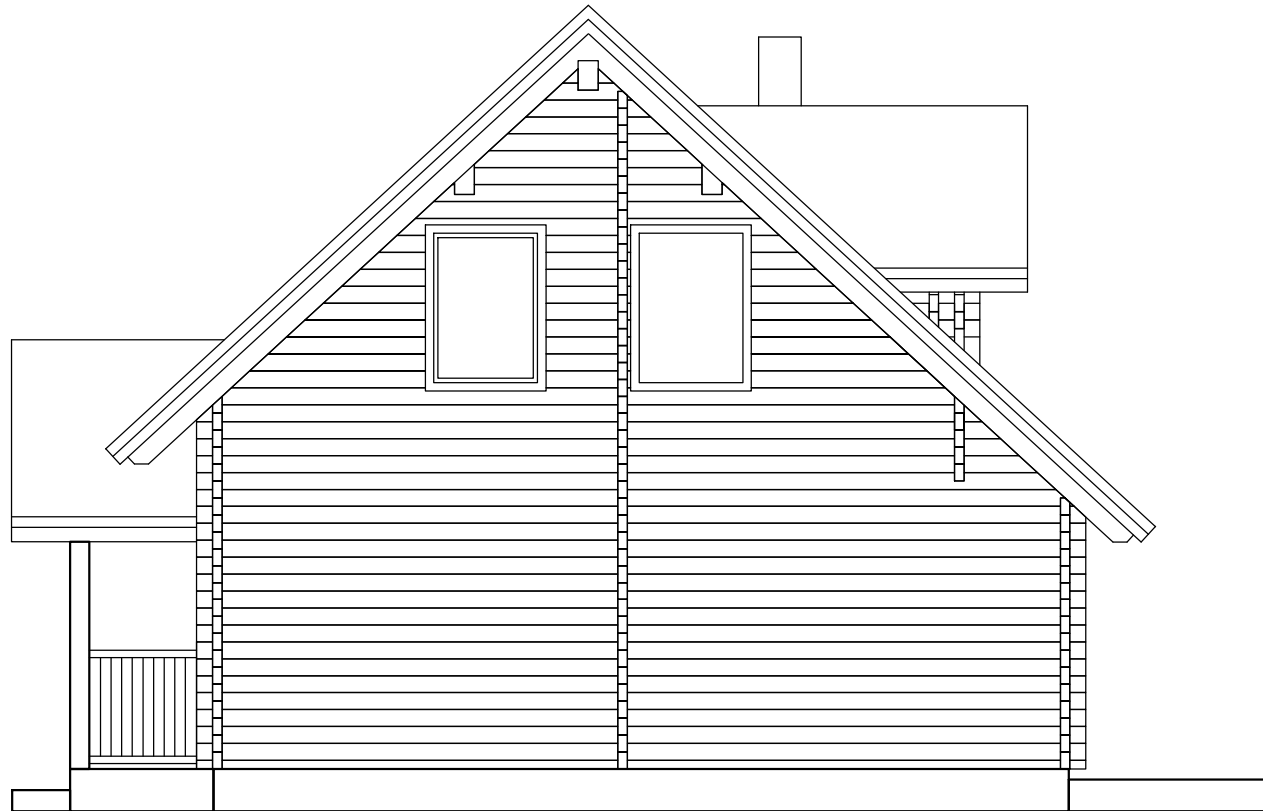

Kood	ANSICHT 4	Leht	
Joonis		Mootkava	1:50
Materjal	9x16	Kuup.	25.11.2014
Joonestaj		File	Wesselbaum.E.dwg



Kood	ANSICHT 1	Leht	
Joonis		Mootkava	1:50
Materjal	9x16	Kuup.	25.11.2014
Joonestas		File	Wesselbaum.E.dwg

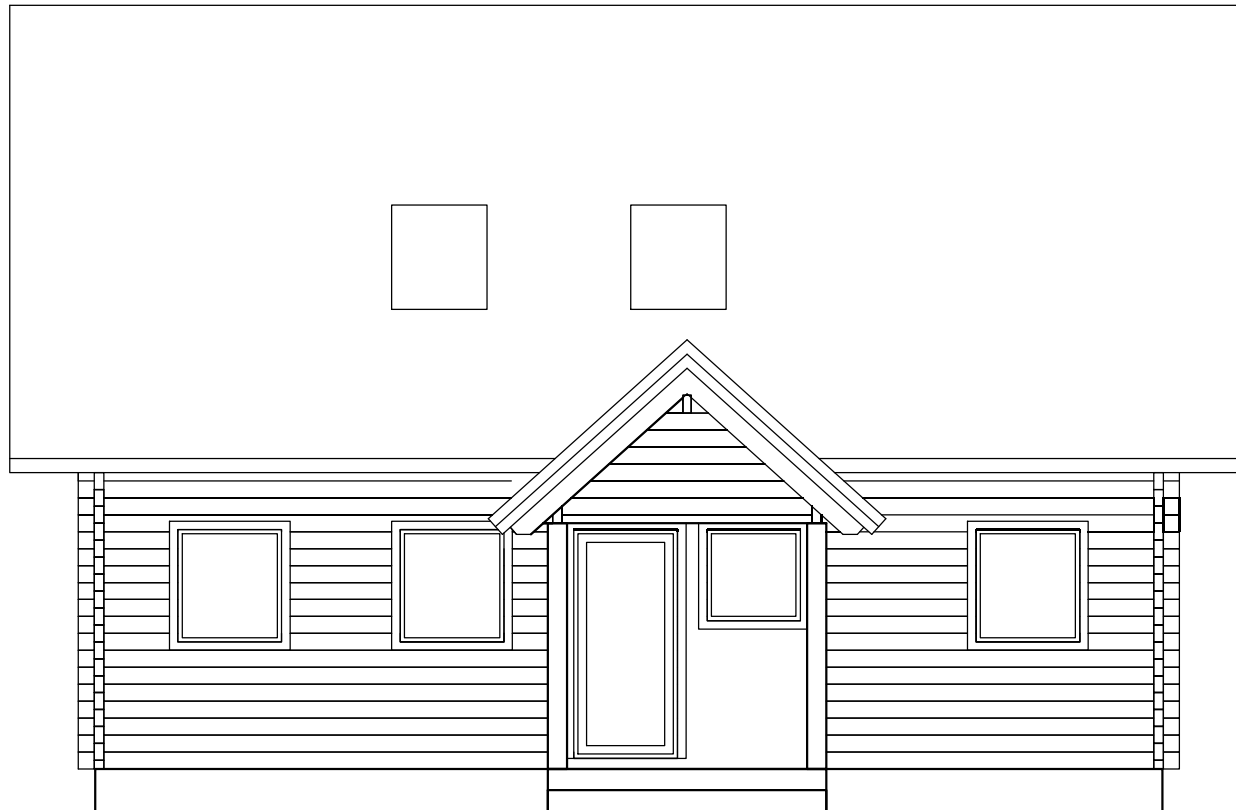

Kood	ANSICHT 3	Leht	
Joonis		Mootkava	1:50
Materjal	9x16	Kuup.	25.11.2014
Joonestas		File	Wesselbaum.E.dwg

